

EXPORT MODEL
MDE/MDG20CS
SUPER-CAPACITY DRYER

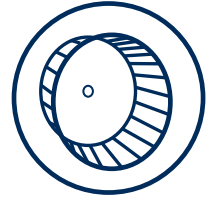

TURBOVENT™ TECHNOLOGY

- Engineered with an extra blower wheel for exceptional performance in long-vent applications.
- Provides efficient drying and boosts productivity.



EXTRA-LARGE CAPACITY

- 7.4-cu.-ft. capacity allows for large loads to be dried effectively and efficiently.
- Optimal drying experience maximizes facility productivity.



EASY-TO-USE CONTROLS

- Mechanical controls provide a simple user interface with robust, easy-to-use knobs.
- Allow owners to customize their machines to set the right price for the right environment.

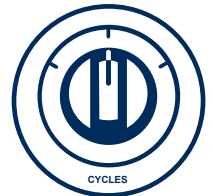

FOUR ROLLER SUSPENSION WITH PERMANENTLY LUBRICATED BEARINGS

- Designed to provide consistent and dependable drying, cycle after cycle.



PORCELAIN-ENAMEL TOP

- Possesses the strength and craftsmanship required for the traffic of a commercial laundry environment.
- Boosts durability and aesthetics.

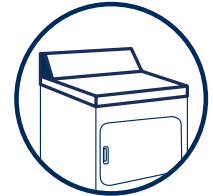

FRONT ACCESS PANEL

- Easy to remove, streamlining service by providing fast access to internal components.

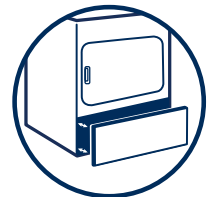

EXTRA-LARGE REVERSIBLE DOOR

- Provides users unhindered access while loading and unloading clothes.
- Offers convenience and optimal flexibility for a given space.

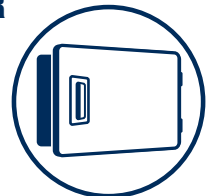

Visit maytagcommerciallaundry.com or call 800-662-3587

MY170020

OUR COMMITMENT TO DEPENDABLE QUALITY

We understand what dependability means to your owners. That's why we use sturdy components and engineer our products to withstand tough commercial laundry environments for years. Our machines deliver consistent results, powerfully cleaning loads of varying sizes with ease. And because we trust our machines to perform, we back them with exceptional warranties. That's what reliability means to Maytag.

MAYTAG® COMMERCIAL SUPER-CAPACITY DRYER

MECHANICAL CONTROLS, COIN SLIDE-READY

DRYER SPECIFICATIONS	
MODEL	MDE/MDG20CSAGW/EXPORT
MOTOR SIZE—HP (KW)	1/3 (.25)
AIRFLOW—CFM MDE/MDG MODEL	215/230
ELECTRIC HEATING ELEMENT (WATTS) EXPORT	4,600
GAS RATING—BTU/HR. (KCAL/HR.)	20,000 (5,040)
GAS INLET SIZE	3/8 N.P.T.
CAPACITY	
Cylinder volume—cu. ft. (liters)	7.4 (210)
Cylinder diameter—in. (mm)	26.26 (667)
Cylinder depth—in. (mm)	23.2 (590)
DIMENSIONS	
Width—in. (mm)	27 (686)
Depth—in. (mm)	29.25 (743)
Height—in. (mm)	43 (1,092)
Door opening—in. (mm)	20.25 (514)
Exhaust duct diameter—in. (mm)	4 (101.6)
CRATED DIMENSIONS	
Width—in. (mm)	28.8 (731)
Depth—in. (mm)	30.8 (782)
Height—in. (mm)	44.65 (1,134)
APPROXIMATE WEIGHT	
Uncrated—lbs. (kg) MDE/MDG model	125 (56.7)/142 (64.4)
Crated—lbs. (kg) MDE/MDG model	135 (61.2)/152 (68.9)
ELECTRICAL REQUIREMENTS	
Electrical rating—voltage/HZ	220–240V/50Hz
Breaker/Fuse—amps MDE/MDG model	25/10
WARRANTY	
	5-Year Limited

Dimensions are for planning purposes only. See specific instructions for proper installation. Because of continuous product improvement, Maytag reserves the right to change specifications without notice.

EXPORT MODEL MDE/MDG20CS SUPER-CAPACITY DRYER

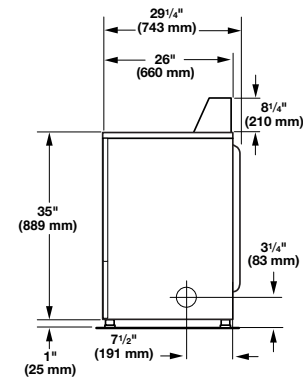

Side View

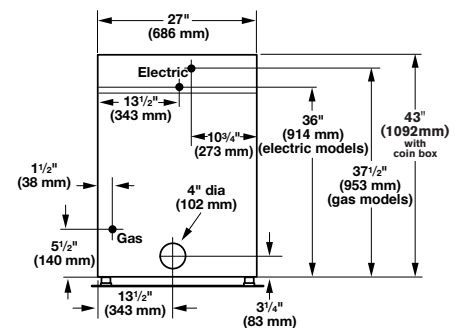

Back View



5-YEAR LIMITED WARRANTY ALL PARTS COVERED

See maytagcommerciallaundry.com for complete warranty details.

MAXIMUM EXHAUST DUCT LENGTH PER NUMBER OF TURNS

Number Of 90° Turns	Rigid Metal Vent	
	Box Hood and Louvered Style	Angled Hood Style
0	135 ft. (41.2 m)	129 ft. (39.3 m)
1	125 ft. (38.1 m)	119 ft. (36.3 m)
2	115 ft. (35.1 m)	109 ft. (33.2 m)
3	106 ft. (32.3 m)	100 ft. (30.5 m)
4	98 ft. (29.9 m)	92 ft. (28.0 m)